

HSF



ROHS

### SPECIFICATION

Current Rating: 3.0Amp  
 Insulation Resistance: 1000MΩ min  
 Contact Resistance: 20MΩ max  
 Withstand Voltage: 1000V AC/DC  
 Operating Temperature: -40°C to +105°C  
 Contact Material: Brass  
 Contact Plating: Au Over Ni  
 Latch plating: Ni  
 Insulator Material: PBT +30%GF UL 94V-0

Ordering Code:

LHDI01 - X - X - X - X - X - X

① ② ③ ④ ⑤ ⑥ ⑦

- ① Series No:
- ② No. of Contacts  
06 08 10 12  
14 16 18 20  
24 26 30 34  
40 50 60 64
- ③ Contact Plating:  
G0:Gold flash S0:Selective  
G1:3U" Gold S1:Selective 3u"  
G2:5u" Gold S2:Selective 5u"  
G3:10u" Gold S3:Selective 10u"  
G4:15u" Gold S4:Selective 15u"  
G5:30u" Gold S5:Selective 30u"  
SN:Tin
- ④ Color Insulator  
B:Black  
U:Blue  
G:Gray
- ⑤ Insulator Material  
A:PBT  
B:PA6T  
C:LCP  
D:PA46  
E:PA9T
- ⑥ Packing  
A:Tray  
B:Bag  
T:Tube  
U:Tube+CAP  
R:Tape&Reel  
W:Tape&Reel+CAP
- ⑦ A:Short Latch  
B:Long Latch  
C:Without Latch

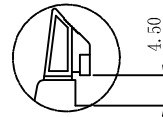
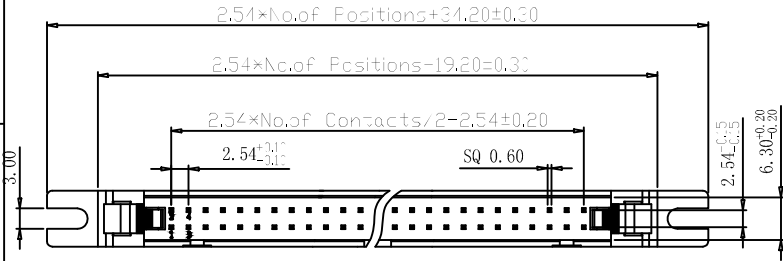

A:Short Latch

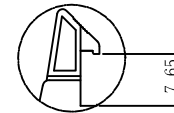

B:Long Latch

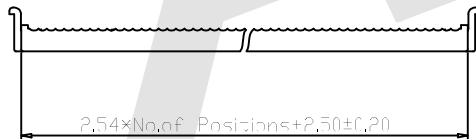
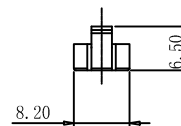
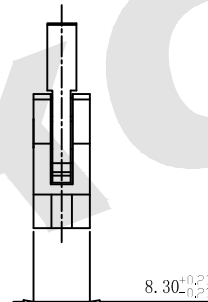
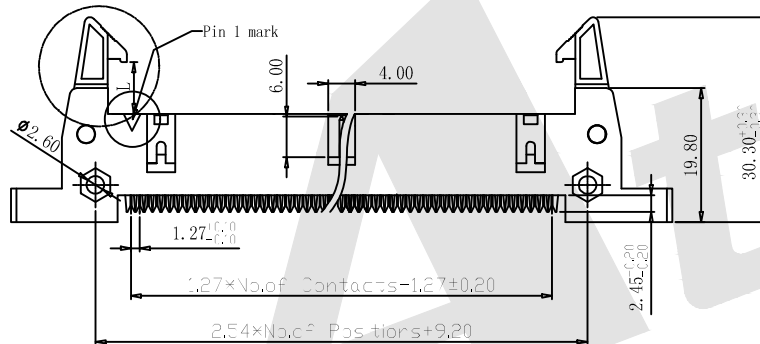

Unless Otherwise specified tolerance  
 X. ±0.35 X.XX: ±0.20  
 X.X: ±0.25 X.XXX: ±0.15

**Atkconn**® ATKCONN ELECTRONICS CO., LTD  
[Http://www.atkconn.com](http://www.atkconn.com)

SCALE: As Shown UNIT: mm  
 DRAW ZLA DATE 24/04/2022  
 CHECK BobYang DATE 24/04/2022

TITLE:  
 2.54mm Ejector Header IDC Type  
 With Mounting Ears

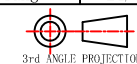

3rd ANGLE PROJECTION

DRAWING NO: LHDI01-XXXXXX  
 PRODUCT NO: LHDI01-XXXXXX

REV	DESCRIPTION	DATE
1		
2		
3		
4		
5		

1 2 3 4 5 6 7 8