



深圳市华浩德电子有限公司

Shenzhen Fahold Electronics Co.,LTd.

地址：深圳市宝安区石岩街道石龙社区石环路 4 号星光工业园 C 栋二、四、五、六楼

Add.:Floor 2,4,5, 6 Building C, Starlight Industrial Park, NO. 4, Shihuan Road,Shilong Community, Shiyan Town, Bao'an District, Shenzhen, China.

Product Name: 产品名称	FD-200U 系列 路灯、工矿灯、高杆灯驱动电源						
Product Model: 产品型号	FD-200U-038/B/C/D	24-38V	3.3-6.5A	CE <input checked="" type="checkbox"/>	FCC <input checked="" type="checkbox"/>	UL <input checked="" type="checkbox"/>	
	FD-200U-042/B/C/D	30-42V	3.1-5.5A	CE <input checked="" type="checkbox"/>	FCC <input checked="" type="checkbox"/>	UL <input checked="" type="checkbox"/>	
	FD-200U-054/B/C/D	36-54V	2.4-4.8A	CE <input checked="" type="checkbox"/>	FCC <input checked="" type="checkbox"/>	UL <input checked="" type="checkbox"/>	
	FD-200U-076/B/C/D	45-76V	1.7-3.4A	CE <input checked="" type="checkbox"/>	FCC <input checked="" type="checkbox"/>	UL <input checked="" type="checkbox"/>	
	FD-200U-143/B/C/D	72-143V	0.9-1.7A	CE <input checked="" type="checkbox"/>	FCC <input checked="" type="checkbox"/>	UL <input checked="" type="checkbox"/>	

IGNATURE AND SEAL BY US /我司签字盖章		
日期:		
Prepared By 编制	Checked By 审核	Approved By 批准

Please confirm and send it back with signature within 7 days.Otherwise we will assume your acceptance.And if any quality dissent ,will execute according to this product specification. 请确认后七日内回签，如不回签则视贵公司默认接受，在发生品质异常时按此份产品规格书执行。		
CUSTOMER APPROVED SIGNATURE /客户承认盖章		
Customer Model No.客户型号:		
日期:		
ENG./工程	QA/品管	OTHER/其他

版本: REV.: 00

Comments 建议:

Feature特征:

- ◆ IP65防护等级
 - ◆ Max output power 200W.最大输出功率200W
 - ◆ Constant current design. 恒流设计
 - ◆ 3 in 1 dimming mode:0-10V,PWM,RX. 三合一调光
调光模式: 0-10v, PWM,RX
 - ◆ Smoothly dimming(0-100%),can dim to off.
从0%-100%平滑调光, 且调光输出可关断
 - ◆ TUV CB CE UL FCC Certified.多个国家与机构认证
 - ◆ PROTECTION: Short Circuit, Open Circuit
保护: 短路保护, 开路保护
 - ◆ Surge protection: 6KV.浪涌保护6KV
 - ◆ SELV safe output design SELV. 安全输出设计
- Application应用**
- ◆ Street lights、High bay lights.路灯、工矿灯

Introduction 介绍

The document detail the electrical, mechanical and environmental specifications of a 200W constant current LED driver with 0-10V Dimming. This LED drive is suitable only for LED load.

此份资料详细描述了一款 200W 系列带 0-10V 调光的 LED 恒流驱动电源的电器性能, 环境要求等。此款电源只适用于 LED 负载。

Model and Key parameters 型号和关键参数

Model 型号	功率 (W)	Output volgag 输出电压(V)	Max.no load voltage 最大空载电压	output current 输出电流(A)	Efficiency 效率(%) @100V	Efficiency 效率(%) @277V
FD-200U-038 /B/C/D	200	24-38	45	3.3-6.5	89	91
FD-200U-042 /B/C/D	200	30-42	45	3.1-5.5	90	92
FD-200U-054 /B/C/D	200	36-54	56	2.4-4.8	90	92
FD-200U-076 /B/C/D	200	45-76	85	1.7-3.4	90	92
FD-200U-143 /B/C/D	200	72-143	150	0.9-1.7	90	92

Note:

1:带载最大电压测试 Max output voltage test

2: 可选字母 B,C,D 或空位, 表示输出增加不同的可选功能。默认空位表示可调电流 (基础机型);B 字母表示可三合一调光并可调电流, C 字母表示不可调光不可调电流, D 字母表示可三合一调光。

Optional letters B, C, D or empty, indicating that the output increases with different optional functions. The default position indicates that the current can be adjustable(basic model); letter B can be three-in-one dimming and fine-tuning current, letter C indicates that non dimmable and output current unadjustable, letter D refers to three-in-one dimming.

Technical data 技术参数

Input characteristics 输入特性	
Input Voltage 输入电压	100-277Vac (Max 305Vac)
Input Frequency 输入频率	47-63Hz
Input Current (Typ.) 输入电流 (典型值)	2.5A @ 100-277 Vac , 100% load
No load Voltage 空载功耗	2Wmax
Inrush Current 浪涌电流	60Amax. @ 277Vac, 25°C
Power factor (Typ.) 功率因数 (典型值)	PF>0.95 @ 100-230 Vac, 100% load, PF>0.92 @ 277Vac 100% load 见图 2
THD 总谐波失真	THD<15% @ 100-277 Vac, 100% load 见图 3
Output characteristics 输出特性	
Current accuracy 电流精度	± 5% I _o
Efficiency 效率	≥89% @ 100 Vac, ≥91% @ 277 Vac, 见图 1
Output Voltage 输出电压	Table 1, 见表 1
Ripple and Noise 纹波与噪声	800mVp-p
Line Regulation 线性调整率	3%I _o
Load Regulation 负载调整率	3%I _o
Turn On Delay Time 开机延时	Under normal conditions, the maximum delay time is 1 second 最大延迟时间小于 2 秒
Protection functions 保护功能	
Open circuit 开路保护	When the LED disconnection the product is protected such as hiccup or when it is at the highest point of output voltage, the power supply shall be self-recovery when the fault condition is removed.当 LED 开路时, 产品进入保护状态, 如打嗝或钳在某输出最高电压状态, 产品不会损伤, 当故障排除或重新开机时, 电源恢复工作正常。
Short Circuit 短路保护	The input power shall decrease when the output rail short, the power supply shall be self-recovery when the fault condition is removed.当输出短路时输入功率会相应减小, 短路情况解除后, 电源自动恢复正常。
Environmental conditions 环境条件	
Operating Temperature 工作温度	-40°C to +60°C
Operating Relative Humidity 湿度	10% to 90% RH, non-condensing
Storage Temperature 储存温度	-40°C to +85°C
Storage Relative Humidity 储存湿度	10% to 90%RH, non-condensing (Sea level to 2,000 m)
Vibration 振动	10 to 500HZ Sweep at constant acceleration of 1.0G (depth: 3.5mm)for 1 Hour for each of the perpendicular axes X, Y, Z.
Degrees of Protection 防护等级	IP65
Safety compliance 安全标准	

■ Dimmable 调光范围 Table 4, 表 4

Function			0-10V				PWM			RX			
Yes Or No			Y				Y			Y			
0-10V	0	1	2	3	4	5	6	7	8	9	10	open	
Ir	-	10.3%	20.9%	30.8%	40.3%	49.8%	59.8%	69.9%	80.1%	90.3%	100%	100%	
PWM	0	10%	20%	30%	40%	50%	60%	70%	80%	90%	99.9%	open	
Ir	-	8.7%	19.1%	29.4%	39.4%	48.8%	58.8%	69.1%	79.3%	89.4%	100%	100%	

Note:

1. Ir is the output current percentages. Ir 为输出电流百分比
2. Ir above is typical values. 以上 Ir 均为典型值

■ Efficiency vs. Output Power 效率与输出功率 P1, 图 1

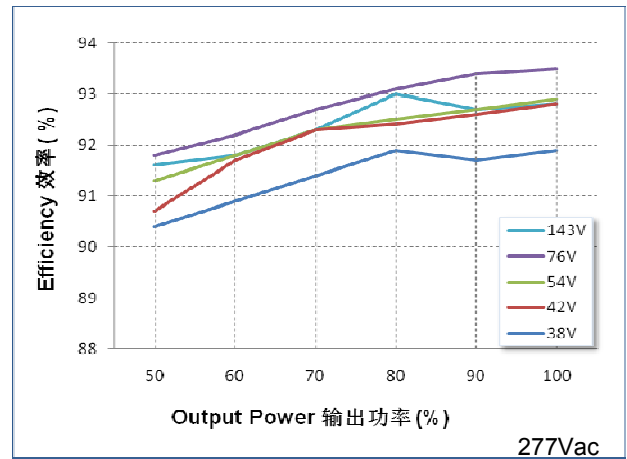
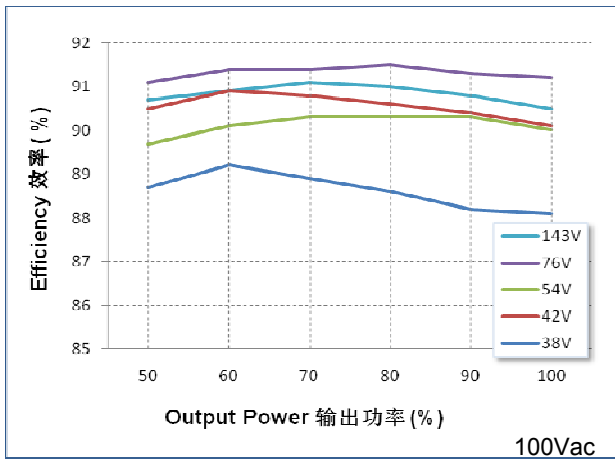

■ Power Factor vs. Output Power 功率因素 P2, 图 2

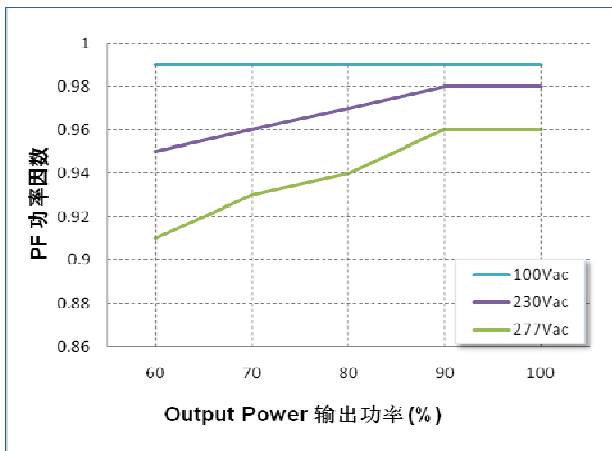

THD vs. Output Power 电流谐波和输出功率 P3, 图 3

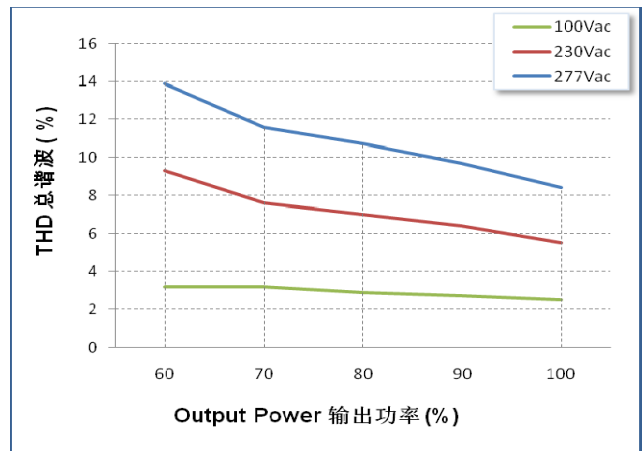

■ Dimming 调光曲线 P4, 图 4

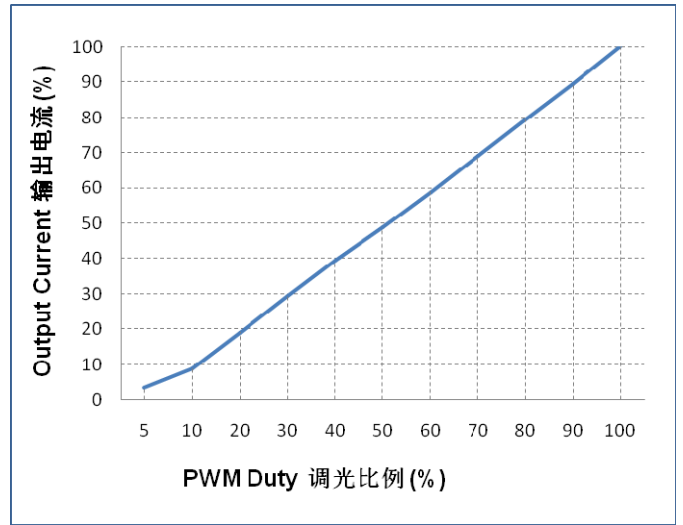
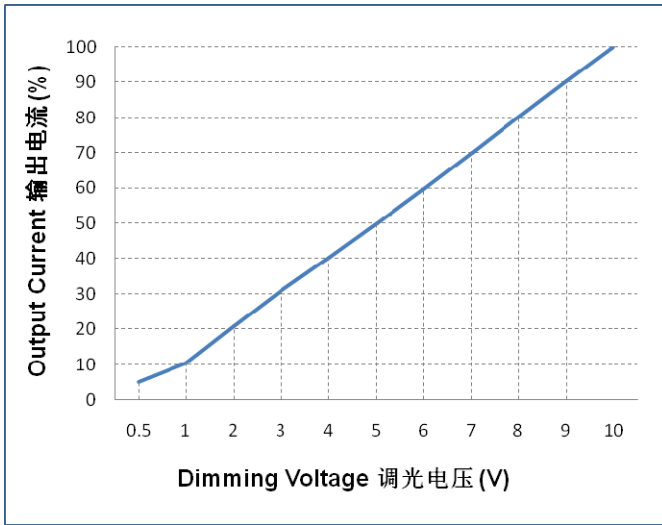

■ Life vs. Tc 寿命和温度 P5, 图 5

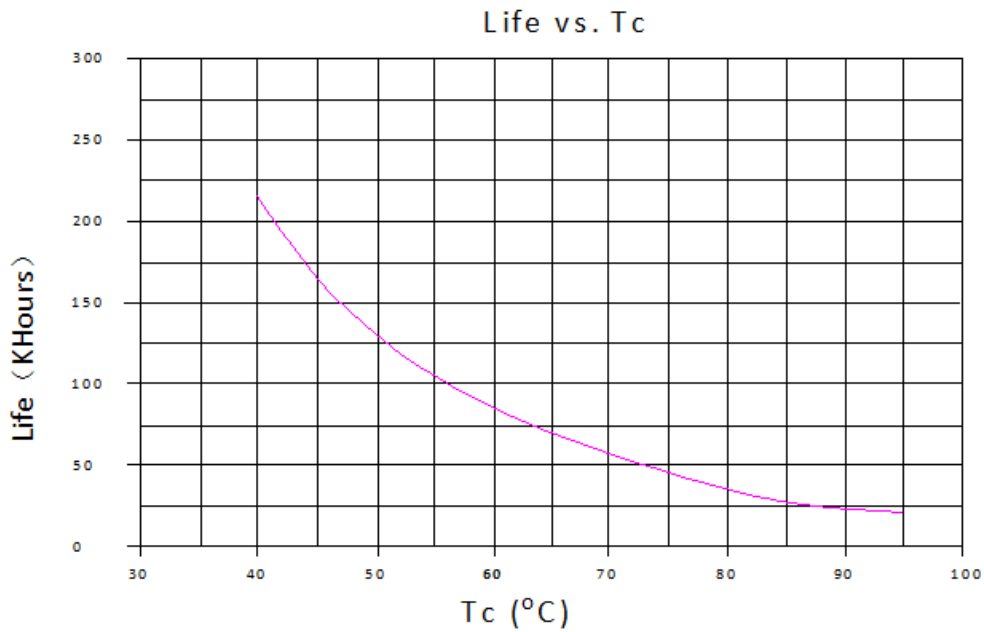

■ Output Voltage vs. Output Current 输出电压和电流范围 P6, 图 6

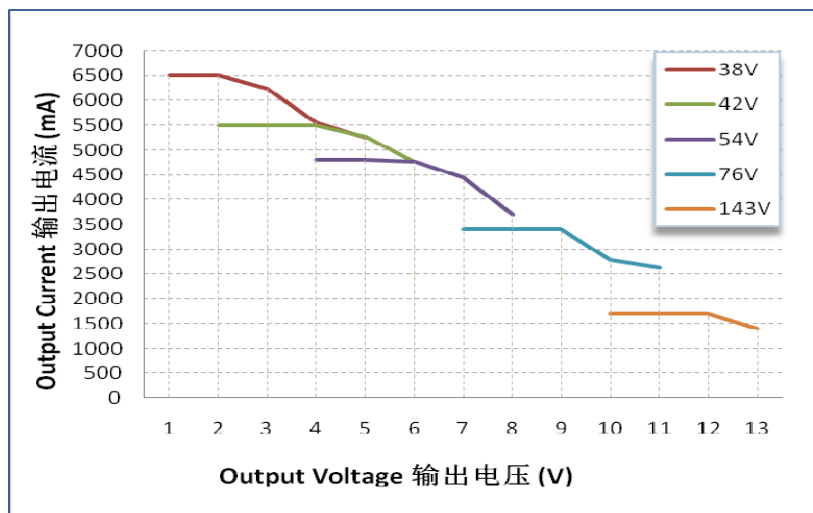

■ Cabling scheme 接线图

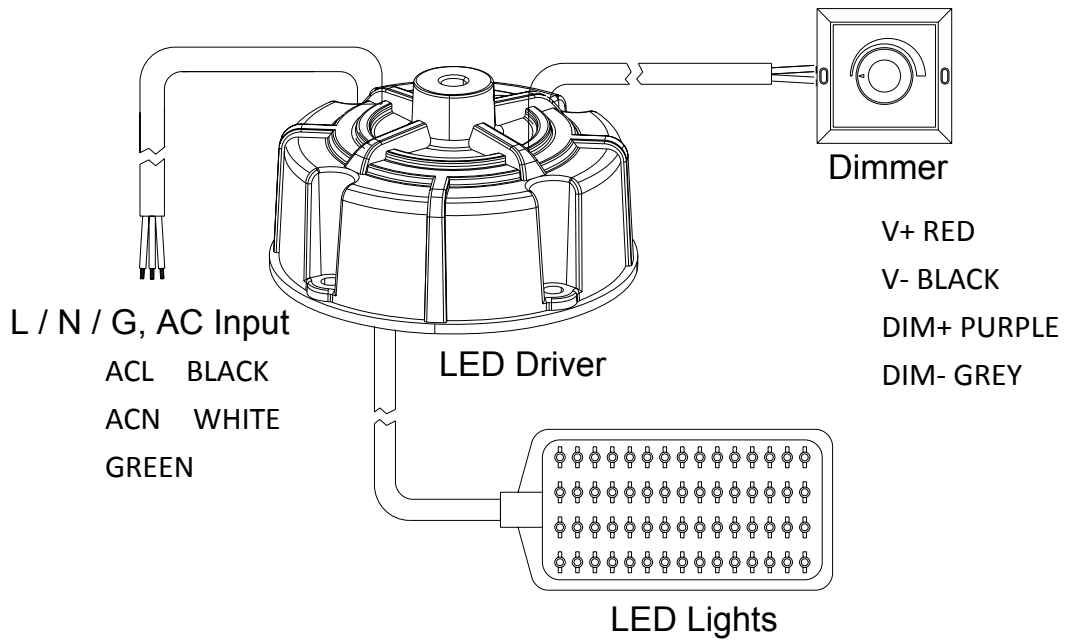

■ Dimensional Drawing (unit: mm)尺寸图

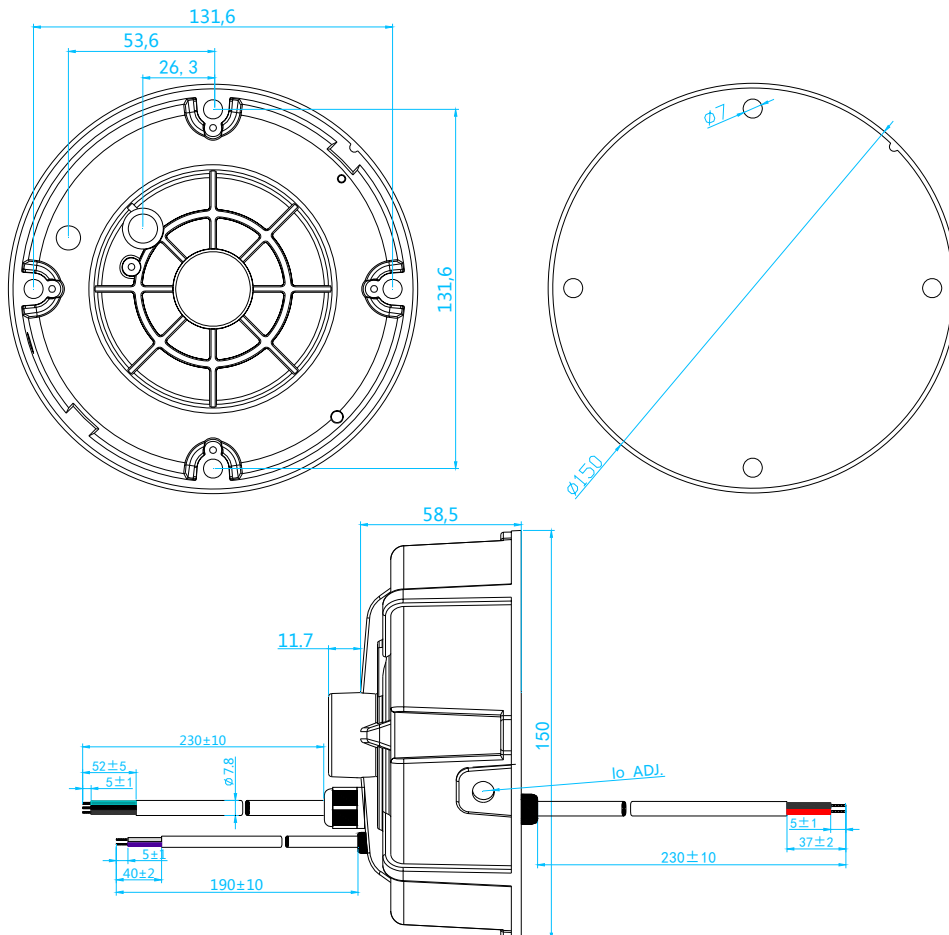

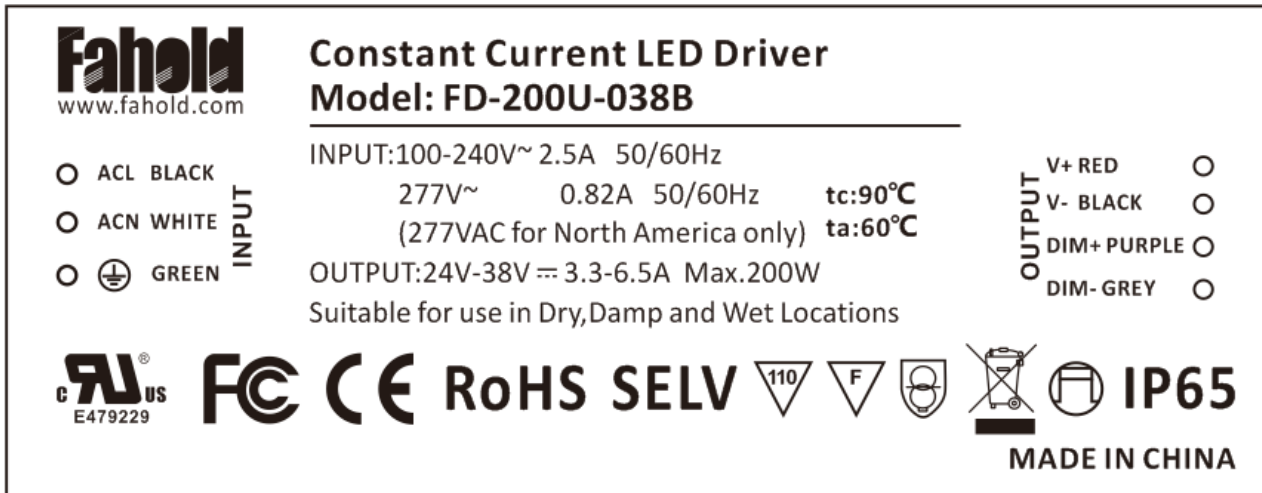
■ LABEL 标签示例

备注：标签根据订单电流勾选 Remark: Label Was Checked According to Order Current Required

安装注意事项 Installation considerations

1. 若产品有外部可调电位器，请在调整好电流之后，建议用 704 硅胶将调整电流的孔密封好，将防水胶塞盖好。

If the power supply has adjustable external potentiometer, after adjust output current, suggest using 704 silicone sealing good the hole and plug waterproof rubber.

2. 电源的防雷等级满足 IEC61000-4-5 等各国的标准要求，如果用在雷电多发地区或电网环境相对复杂的地区，建议在电源的 AC 输入端加装专业的防雷模块。

Lightning protection level to meeting IEC61000-4-5 standard requirement, if you use the lightning occurs or the area of power grid environment is relatively complex, suggest in the power supply of the AC input terminal equipped with professional lightning protection module.

包装, 运输, 贮存 Package, Transportation & Storage
1. 包装 Package

a. 包装箱的外形尺寸为 (单位: mm): 长 X 宽 X 高 = 420 X 420 X 230;
package box outside dimension: L X W X H = 420 X 420 X 230 (unit: mm);

b. 每箱产品的包装数量为 12 台;
product number in each box: 12 PCS;

c. 整箱毛重 KG
whole box gross weight: kg;

2. 运输 Transportation

适用于车, 船, 飞机运输, 运输中应遮蓬, 防晒, 文明装卸。

Packaging is designed suitable for transportation by truck, ship, and plane. The products should be shielded from sunshine, and loaded and unloaded carefully.

3. 贮存 Storage

产品贮存应符合 GB3873-83 的规定。

贮存期限超过一年的产品要重新检验, 合格后方可使用。

The product storage meet the standard of the GB 3873-83.

Product should be rechecked over 1 year.